

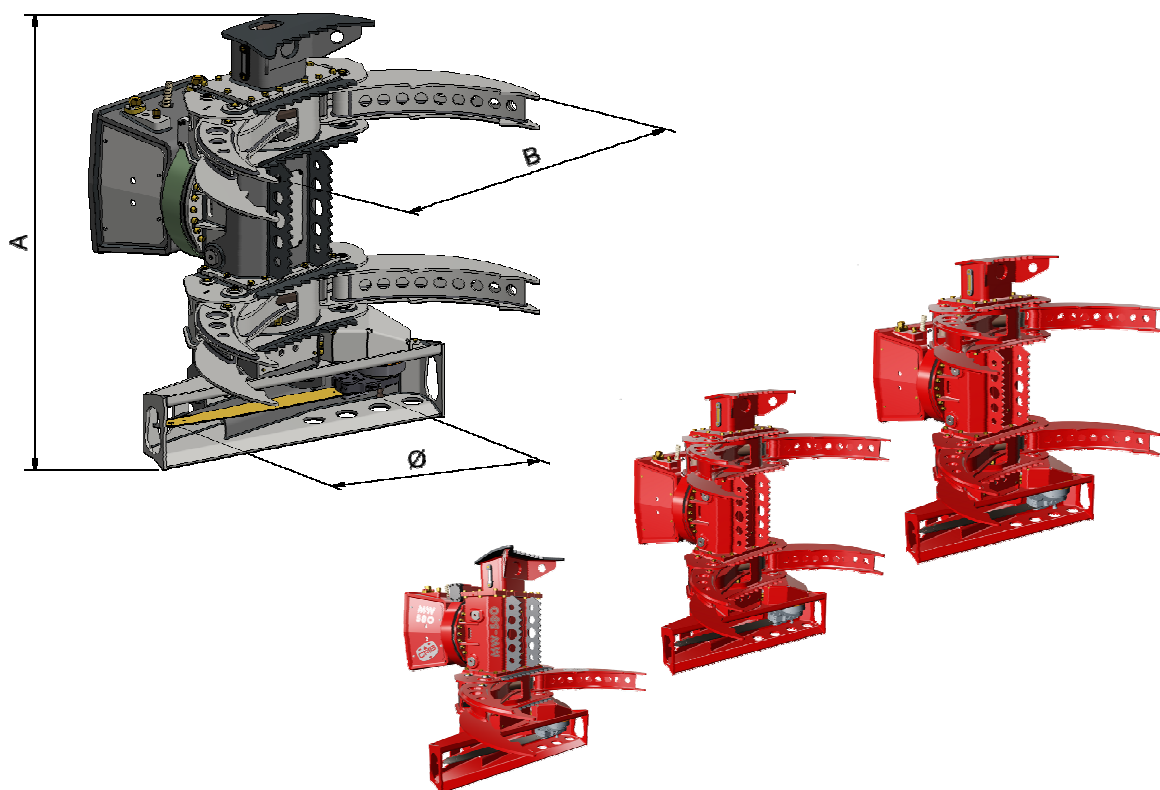







## Serie MW

CESOIA MOTOSEGA PER DEFORESTAZIONE  
 GRAPPLE SAW  
 PINCE SCIE  
 GARRA CON UNIDAD DE SIERRA  
 DIE GREIFERESAGE



	MW - 580 Short T	MW - 580 Short E	MW - 580	MW - 780
 ton.	10 - 20	10 - 20	14 - 22	20 - 28
 Ø max. Legno debole	580	580	580	750
 Ø max. Legno duro	580	580	580	750
A Altezza attrezzatura	1600	1600	1850	2100
B Apertura Pinza	1450	1450	1450	1600
Ø Lunghezza barra	900	900	900	1200
Rotazione continua	360°	360°	360°	360°
Funzione di inclinazione per taglio	Optional	Optional	Automatico	Automatico
Sospensioni	Attive	Attive	Attive	Attive
Lubrificazione catena	Olio	Olio	Olio	Olio
 Kg	1000	900	1260	1600
 bar	250	250	250	250
 l/min	110 - 150	110 - 150	110 - 150	140 - 170
 bar	175	175	175	175
 l/min	50 / 70	50 / 70	50 / 70	50 / 70
Tensione Elettrovalvola	V	*	12	12

T= Caricatore Telescopico

E= Escavatore